

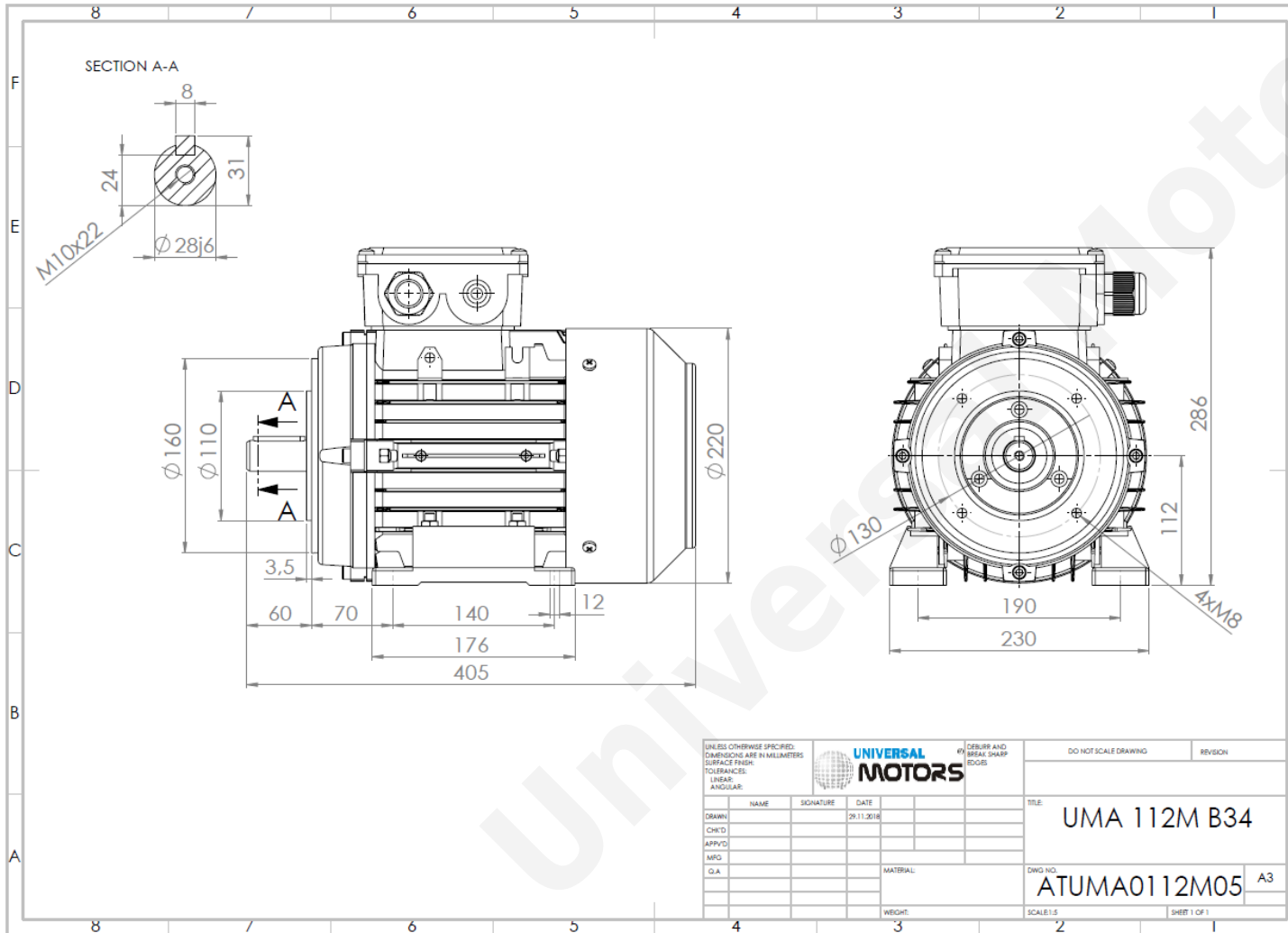

TECHNICAL DATA

Three Phase Electric Motors - Aluminum Frame
 UM2A 112M2-2
 5.5 kW / 7.5 Cv
 2920 RPM



Motor type:	UM2A 112M2-2
Output:	5.5 kW / 7.5 Cv
Speed (min ⁻¹):	2920 RPM
Frequency:	50 Hz
Voltage:	400 V
Current:	10.5 A
Power factor (Cos Ø):	0.87
Poles:	2
Insulation class:	F
Temperature rise Class:	B
Efficiency 50%:	86.1 %
Efficiency 75%:	87.3 %
Efficiency 100%:	87.0 %
Torque:	18 N.m
Tstarting/Tnominal:	3.4
Istarting/Inominal:	10.2
Tmaximum/Tnominal:	4.1
Noise:	78 Db(A)
Weight:	32.5 Kg
Brake AC:	AC6
Torque Brake DC:	60 N.m
Bearing DE:	6306 2Z
Bearing NDE:	6206 2Z
Torque Brake AC:	60 N.m
Brake DC:	REB-05-14

Regime - S1

Altitude - 1000m

Environment Temperature - 40°C

CONTACTS:

UNIVERSAL MOTORS Tel: +351 252 299 080
 Rua de São Brás,745 Fax: +351 252 299 089
 4480-782 VILA DO CONDE Mail: geral@universalmotors.pt

* References applied only in the UK